

New features of the Franck-Hertz experiment

Gerald Rapior, Klaus Sengstock, and Valery Baev^{a)}

Institut für Laser-Physik, Universität Hamburg, Luruper Chaussee 149, 22761 Hamburg, Germany

(Received 29 September 2005; accepted 20 January 2006)

The fundamental properties of the signal structure in Franck-Hertz experiments are analyzed. The central result is that the spacings between the minima in Franck-Hertz curves are not equidistant but increase linearly with the number of minima. This increase is especially pronounced at low atomic pressure. We suggest that the increase of the spacings is caused by the additional acceleration of electrons over their mean free path after the excitation energy is reached. Our model accurately estimates the lowest excitation energies of mercury (4.67 eV) and neon (16.6 eV) atoms and the mean free path of electrons in standard Franck-Hertz experiments. These results contradict the usual assumption that the spacings between successive minima or maxima are equal. We demonstrate that a standard Franck-Hertz apparatus can be upgraded to do more advanced experiments. © 2006

American Association of Physics Teachers.

[DOI: 10.1119/1.2174033]

I. INTRODUCTION

The Franck-Hertz experiment on electron-mercury collisions is one of the key demonstrations of the quantum behavior of atoms and provides a direct nonoptical demonstration of the existence of discrete stationary energy levels in atoms. In 1925 Franck and Hertz received the Nobel Prize for this work.^{1,2} It is widely used in undergraduate physics teaching laboratories. Usually the experiment is limited to the determination of the energy required to excite the first energy levels of mercury or neon atoms.

A typical arrangement of the Franck-Hertz experiment with a Hg or Ne tube is shown in Fig. 1. The tube consists of an indirectly heated cathode C , two grids G_1 and G_2 separated by a distance L , and an anode A . A small voltage U_1 can be applied between the cathode C and grid G_1 to control the emission of electrons. The presence of this voltage is not critical and in some tubes G_1 is absent. An accelerating voltage U_2 is applied between the two grids, where electrons can gain enough energy to create inelastic collisions with atoms. A small retarding voltage U_3 is applied between grid G_2 and anode A so that an electron that has undergone an inelastic collision close to G_2 has insufficient energy to reach the anode. The mercury tube needs to be heated to a temperature between 140 °C and 200 °C so that mercury pressure is sufficiently high.

When the electron energy is high enough to overcome the retarding potential U_3 , they reach the anode and are included in the measured anode current I . Electrons with an energy less than eU_3 are unable to reach the anode and are collected by the grid G_2 instead. For small accelerating voltages U_2 the anode current characteristics of a Franck-Hertz tube are similar to that of a triode. For greater voltages U_2 , electrons are accelerated between the grids until they have enough energy to excite an atom. At this voltage the anode current decreases and passes through a minimum when almost every electron has suffered an inelastic collision. Subsequently the excited atoms return to their ground state by the spontaneous emission of a photon. At the voltage corresponding to the current dip a light emission in the tube near the second grid can be observed.^{3,4} A further increase of U_2 leads to the additional acceleration of electrons until they gain enough energy to excite an atom again. As a result the anode current passes through its second minimum, corresponding to two inelastic

collisions of each of the free electrons with atoms. This process repeats with the increase of the voltage U_2 , and several current dips can be observed at nearly integer multiples of the excitation energy of the atoms in the current-voltage diagram (the Franck-Hertz curve).

It is generally assumed that all the maxima or minima spacings in Franck-Hertz curves are equal and correspond to the first excitation energy of atoms.⁴⁻⁸ It is even suggested that the magnitude of the lowest excitation energy can be calculated by using the mean value of the maxima⁸ or minima⁹ spacings. Depending on the pressure in the tube and the number of measured spacings, these determinations for Hg atoms range from 4.8 to 5.1 eV. This result contradicts the expected value¹⁰ of 4.67 eV for the lowest excitation in Hg atoms, $6^1S_0 \rightarrow 6^3P_0$ (see Fig. 2). Higher values for the lowest excitation energy of Hg atoms determined from the experimental data have usually been identified with the transitions to the second $6^1S_0 \rightarrow 6^3P_1$ (4.89 eV) or to the third $6^1S_0 \rightarrow 6^3P_2$ (5.46 eV) excited levels, which are claimed to be stronger.⁷

It is not generally realized that the spacings between the maxima and the minima in the experimental records are not equidistant, although the continuous increase of these spacings as a function of the order of the minima or maxima is usually visible.⁴⁻⁹ In this article we present data that demonstrates the increase of the spacings and introduce a model explaining this increase. Our model provides accurate determinations of the energies of the first excitation levels of mercury and neon atoms that compare well with published values. In addition, we obtain information on the mean free path of the electrons and on the cross section of inelastic collisions of electrons with atoms.

II. EXPERIMENTS WITH A MERCURY TUBE

The Franck-Hertz experiment with Hg atoms has been performed with a commercial experimental apparatus.⁹ It is similar to the apparatus shown schematically in Fig. 1 except the grid G_1 is absent. The distance between the cathode and grid G_2 is $L=7$ mm. Figure 3 shows a Franck-Hertz curve with the Hg tube at the temperature $T=170$ °C. The anode current increases and oscillates as the voltage U_2 increases and shows 12 dips of the anode current. The separation between the 4th and the 12th dip is 39.1 V. The first three dips

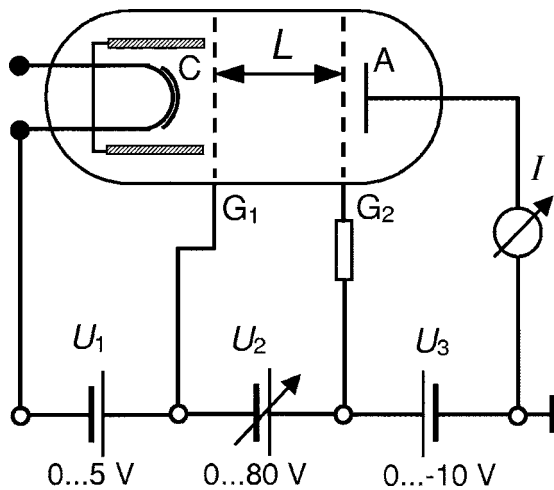

Fig. 1. Schematic diagram of the Franck-Hertz experiment.

are not very well defined and are excluded from the data analysis. The mean spacing is $(39.1 \text{ V})/8=4.89 \text{ V}$ and is larger than the first excitation energy in mercury, 4.67 eV . An accurate evaluation of the individual spacings between the minima as well as between the maxima reveals their systematic increase. The spacing between the 4th and the 5th minimum is 4.78 eV , whereas the spacing between the 11th and the 12th minimum is 5.03 eV . We will show that this increase is due to the additional acceleration of electrons over the mean free path after the excitation energy has been reached, but before inelastic collisions with atoms occur.

The observed increase of the spacing between the maxima and minima varies with the temperature of the Hg tube. Figure 4 shows that three spacings in the Franck-Hertz curve at 145°C correspond to 3.25 spacings at 200°C . This ob-

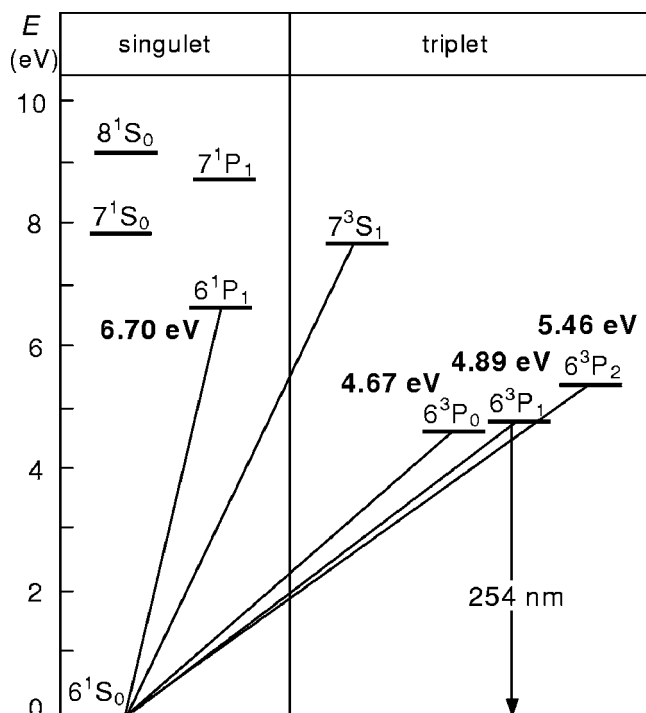

Fig. 2. Lowest energy levels in Hg (Ref. 10).

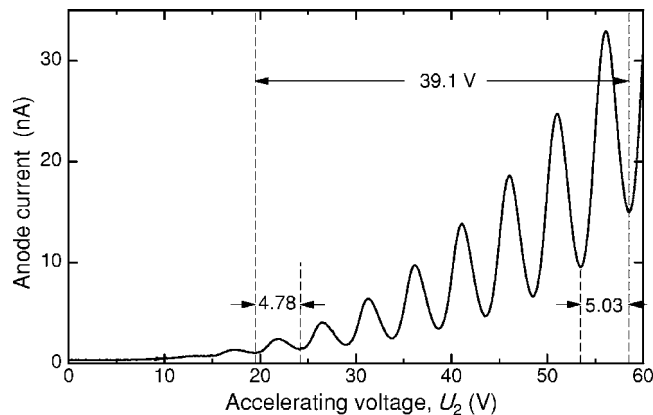

Fig. 3. Typical Franck-Hertz curve recorded with Hg tube at 170°C .

servation supports our model, because the mean free path of the electrons decreases with the atomic density and therefore with the tube temperature.

III. MODEL OF INELASTIC COLLISIONS

Figure 5 shows the motion of an electron between two grids in a Hg tube in the presence of the accelerating potential U_2 . While it accelerates the electron gains energy and collides with mercury atoms. If the electron energy is smaller than the lowest excitation energy of the mercury atoms, the collisions are elastic and the energy loss by the electron is very small because of the large mass difference between the colliding particles. If the electron energy reaches the excitation threshold of Hg atoms, inelastic collisions may occur. Before the inelastic collision takes place, an electron must come close to a mercury atom. The average distance that an electron moves before the inelastic collision takes place is the mean free path λ . The electrons continue to gain energy over a distance equal to the mean free path and can excite not only the lowest but also one of the higher energy states of the

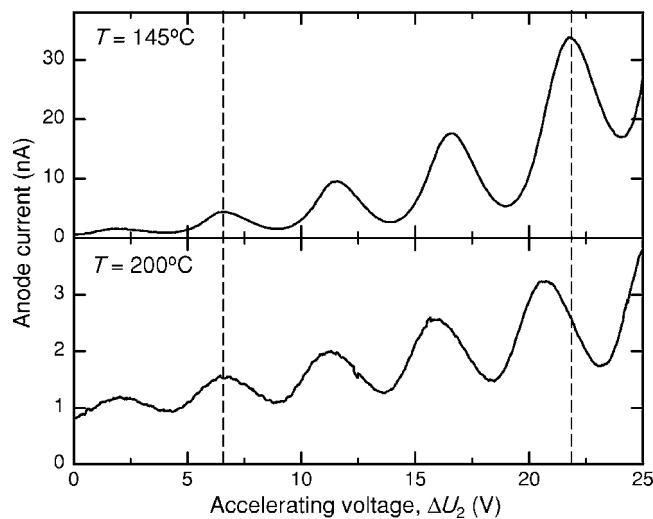

Fig. 4. Franck-Hertz curves recorded with Hg atoms at two different tube temperatures. The curves are shifted horizontally so that two of the maxima coincide.

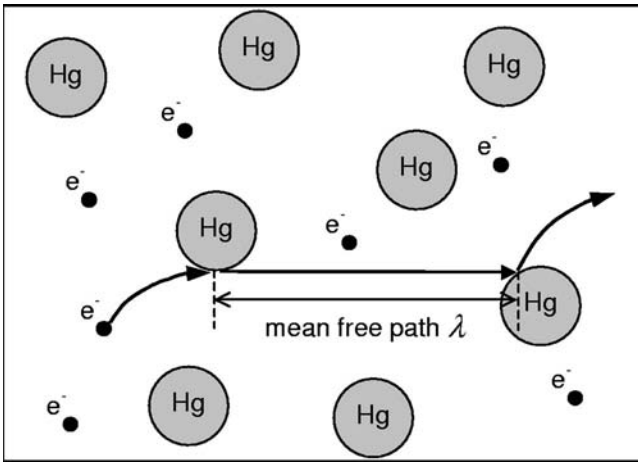

Fig. 5. Schematic of the energy transfer from electrons to atoms.

atoms. This phenomenon significantly modifies the Franck-Hertz curves and has to be taken into account when analyzing the experimental data.

Figure 6(a) shows the energy gain of a free electron moving in the tube between the two grids. The potential U_2 is set slightly above the first excited state of the atoms so that electrons, after reaching the lowest excitation energy E_a , move an additional distance λ before they reach the second grid G_2 . Over this distance the electrons gain the additional energy δ_1 and with a high probability inelastically collide with atoms. We assume that an electron loses most of its energy after an inelastic collision, corresponding to the idea

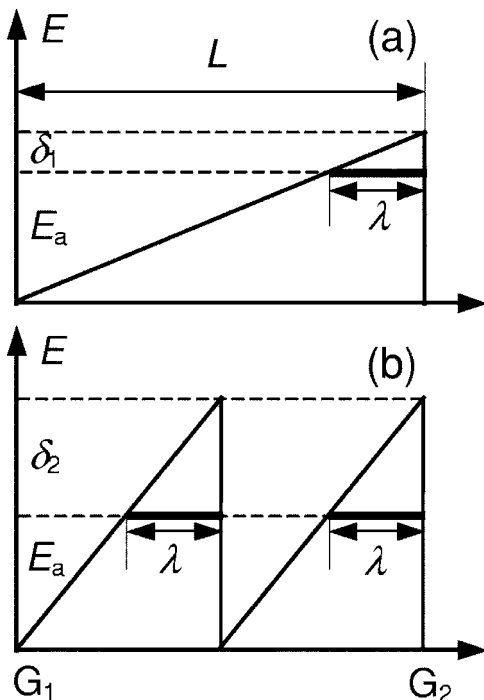

Fig. 6. Electron energy between grids G_1 and G_2 in a Franck-Hertz tube with an accelerating voltage sufficient for one (a) and two (b) inelastic collisions. E_a is the lowest excitation energy of atoms, and δ_1 and δ_2 are additional energies gained by the electrons along the mean free path λ .

that there are many other energy states in the atom above E_a that can be excited. This assumption is justified for both Hg and Ne atoms.

Figure 6(b) illustrates how an electron gains energy at a higher accelerating potential in comparison to Fig. 6(a). Because the electric field is higher, electrons gain more energy ($\delta_2 > \delta_1$) along the mean free path λ . Electrons inelastically collide twice with atoms and their total energy gained in the electric field between two grids is $E_2 = 2E_a + 2\delta_2$. This case corresponds to the second minimum in a Franck-Hertz curve.

For n inelastic collisions the energy gained by the electrons is

$$E_n = n(E_a + \delta_n). \quad (1)$$

At typical tube pressures, the mean free path of the electrons is much less than the distance between two grids, $\lambda \ll L$. With this assumption we have $\delta_n \ll E_a$ and

$$\delta_n = n \frac{\lambda}{L} E_a. \quad (2)$$

If we use Eqs. (1) and (2), the spacing between two minima in a Franck-Hertz curve is given by

$$\Delta E(n) = E_n - E_{n-1} = \left[1 + \frac{\lambda}{L} (2n - 1) \right] E_a. \quad (3)$$

Equation (3) shows that the spacing $\Delta E(n)$ between the minima increases linearly with the minimum order n . The lowest excitation energy E_a derived from Eq. (3) is

$$E_a = \Delta E(0.5). \quad (4)$$

This value corresponds to the minima spacing $\Delta E(n)$ extrapolated to $n=0.5$. As a consequence the lowest excitation energy of atoms cannot be directly measured from Franck-Hertz curves as is usually suggested, because this energy is smaller than the first measured spacing at $n=2$, that is, between the first and the second minimum. (The spacing for $n=1$ is usually not evaluated because it depends on tube parameters.)

The mean free path of the electrons can also be derived from Eq. (3),

$$\lambda = \frac{L}{2E_a} \frac{d\Delta E(n)}{dn}. \quad (5)$$

We have assumed that the electric field between the grid G_2 and the anode is much stronger than the field between the two grids. In a typical Franck-Hertz experiment this condition is usually satisfied because the distance between the two grids is usually much larger than the distance between the second grid G_2 and the anode, but in the following we will give an example where this condition is not satisfied.

IV. THE LOWEST EXCITATION ENERGY OF Hg ATOMS AND THE MEAN FREE PATH OF THE ELECTRONS

Our measured results for the Franck-Hertz experiment with a mercury tube at different temperatures are shown in Fig. 7. The measured spacings ΔE between the minima of the Franck-Hertz curves are shown as a function of the minimum order n for four temperatures $145^\circ\text{C} < T < 190^\circ\text{C}$ of the tube, together with the linear fits according to Eq. (3). These results show a linear increase of the spacings with n

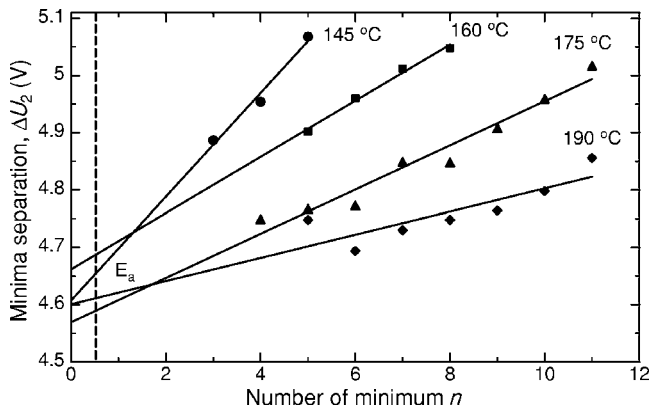

Fig. 7. Spacings ΔE between the minima in the Franck-Hertz curves measured with a Hg tube at four temperatures as a function of the minimum order n . The corresponding linear fits (solid lines) according to Eq. (3) are also shown.

for all temperatures according to Eq. (3). We have not observed a decrease of the spacings as expected from the alternative model, which takes into account the nonuniform distribution of the electric field in the experiments.¹¹ The slope of the linear fits of $\Delta E(n)$ in Fig. 7 decreases with the temperature. This decrease is expected from our model because the mean free path of the electrons in the mercury tube decreases with atomic density and therefore with the tube temperature.

Figure 7 shows that all the linear fits to the experimental data converge at approximately $n=0.5$ (dashed line). According to Eq. (4) the value of $\Delta E(0.5)$ corresponds to the lowest excitation energy E_a of the atoms. The values of $\Delta E(0.5)$ obtained from the linear fits of the data for nine temperatures in the range $140^\circ\text{C} < T < 200^\circ\text{C}$ are shown in Fig. 8. The error bars show a lower limit because they only include statistical errors obtained from the linear fits. Within the expected accuracy the minima spacings show no dependence on the temperature; their mean value 4.65 ± 0.03 V corresponds to the lowest excitation energy, 4.67 eV, in Hg atoms ($6^1S_0 \rightarrow 6^3P_0$).¹⁰ To our knowledge, this experiment is the first determination of the lowest excitation energy of Hg atoms made with a standard Franck-Hertz experiment. Note that even the energy resolved measurements with more so-

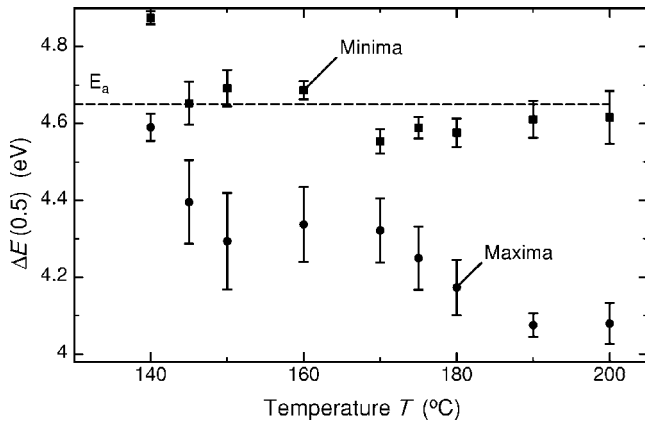

Fig. 8. Lowest excitation energy in Hg-atoms determined with Eq. (4) by evaluating minima (filled square) or maxima (●) spacings as a function of the tube temperature T .

Table I. The values of the mean free path λ of the electrons in the Hg tube for different temperatures.

T ($^\circ\text{C}$)	145	160	175	190
$d\Delta E/dn$ (V)	0.091	0.049	0.039	0.02
λ (mm)	0.097	0.052	0.041	0.022

phisticated versions of the Franck-Hertz experiment do not resolve the lowest excited state 6^3P_0 in mercury.^{6,12}

The determination of the lowest excitation energy of mercury is often performed by measuring the spacings between the maxima in Franck-Hertz curves. To verify this approach we determined the values of E_a from the spacings between the maxima. Figure 8 shows that these values are lower than expected and vary with the tube temperature. The reason is that the maxima correspond to inelastic collisions of relatively high energy electrons. The distribution of the electron energy depends on various tube parameters and varies with the maximum order. Moreover, the accuracy of the measurements of the positions of the maxima is affected by the overlap of the oscillations and a rapid general increase of the anode current. Therefore, it is more appropriate to determine the spacings between the minima of the current. The minima correspond to inelastic collisions of the electrons possessing the most probable energy and hence to the local maxima of the light emission in the tube.⁴

The mean free path λ of the electrons for inelastic collisions in the tube is determined according to Eq. (5) by the slope of the linear fit of $\Delta E(n)$. The values corresponding to the data in Fig. 7 are given in Table I. The mean free path decreases with the temperature and thus with the atomic density N as¹⁰

$$\lambda = \frac{1}{N\sigma} = \frac{k_B T}{p\sigma}, \quad (6)$$

where σ is the cross section for inelastic collisions, k_B is Boltzmann's constant, p is the pressure of the mercury vapor, and T is the tube temperature expressed in Kelvin. In the temperature range from 300 to 500 K the mercury pressure p (in Pa) is approximated¹³

$$p = 8.7 \times 10^{(9-(3110/T))}. \quad (7)$$

Figure 9 shows the values of the mean free path λ deter-

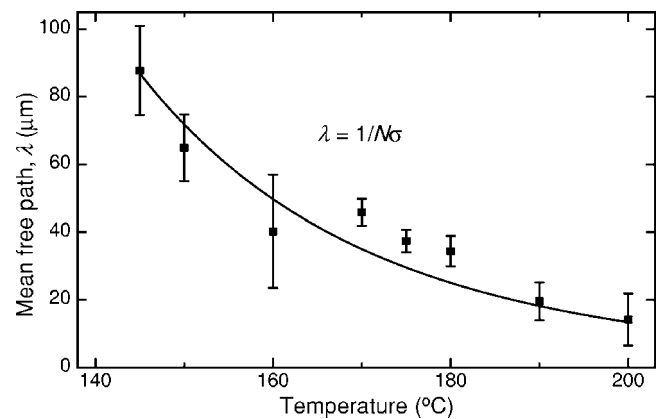

Fig. 9. Dependence of the mean free path λ on the tube temperature. The curve represents the fit of the experimental data to Eq. (6).

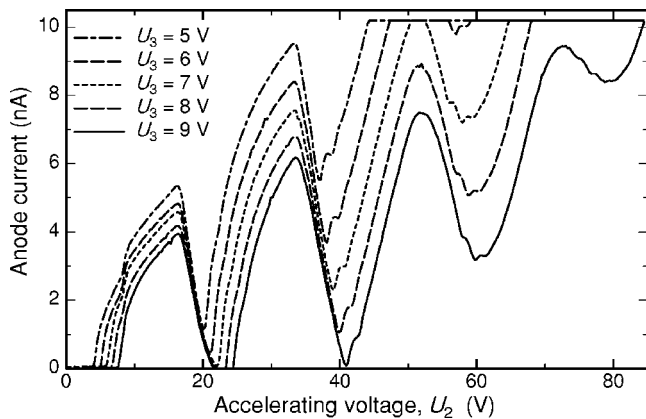

Fig. 10. Franck-Hertz curves recorded with a Ne tube at several retarding voltages U_3 .

mined in the experiment as a function of the temperature. The curve is the fit of the experimental data using Eqs. (6) and (7). The cross section for inelastic collisions obtained from this fit is $\sigma = (2.1 \pm 0.1) \times 10^{-19} \text{ m}^2$. This value agrees with the cross section for the electron excitation of the mercury state 6^3P_0 given in Ref. 7.

V. EXPERIMENTS WITH A NEON TUBE

We also performed Franck-Hertz experiments with neon. This experimental setup (Leybold Didactic GmbH, model 555870) is similar to the setup shown in Fig. 1. The curves measured with a neon tube at different values of the retarding potential U_3 are shown in Fig. 10. The minima of these curves reveal a systematic substructure. We explain this substructure by the excitation of additional energy levels of neon atoms above the lowest excited state. Figure 11 shows that the first 14 excited levels in neon are divided into two groups, E_{a1} and E_{a2} , with a spacing of about $\Delta E = 1.7 \text{ eV}$.¹⁴ According to our model, electrons gain additional energy over the mean free path and excite not only the lowest en-

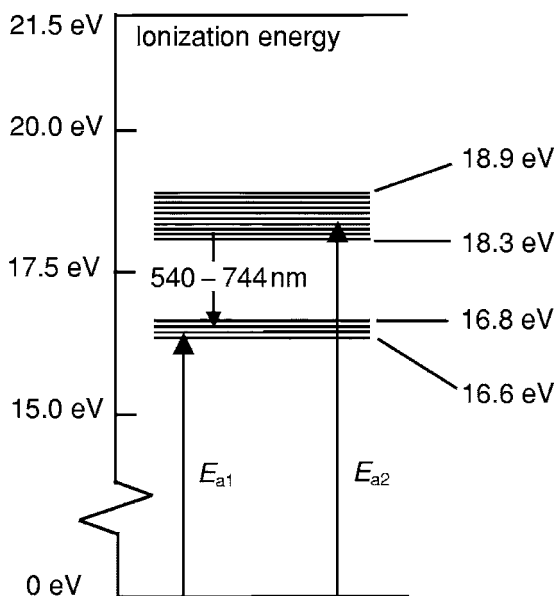

Fig. 11. Selected energy levels of neon (Ref. 14).

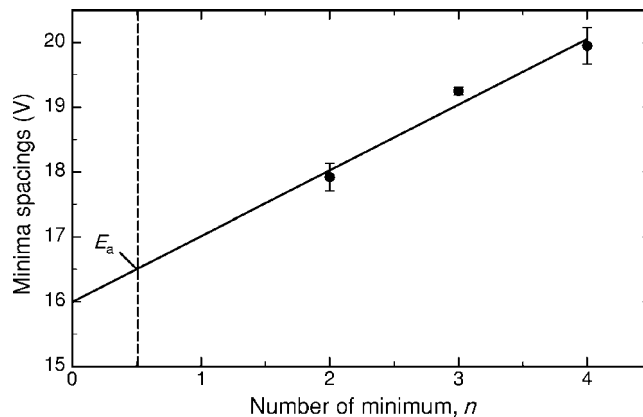

Fig. 12. Spacings between minima in the Franck-Hertz curve measured with a Ne tube as a function of the minimum order n . The corresponding linear fit (solid line) according to Eq. (3) is also shown.

ergy level E_{a1} of Ne atoms, but also one of the higher excited states, for example, E_{a2} . Therefore, the minima in the Franck-Hertz curves are divided into local dips corresponding to the energy separation between E_{a1} and E_{a2} . The number of the dips increases with the minimum order, because the electrons exciting E_{a2} and E_{a1} levels have different initial conditions for the next inelastic collision. The evidence for the excitation of E_{a2} levels in neon is provided by the visible light emitting zones inside the Franck-Hertz tube in the range from 540 to 744 nm. This emission corresponds to the spontaneous transition in neon atoms from E_{a2} to E_{a1} levels. We see that a standard commercial Franck-Hertz experiment allows us to resolve different energy states in neon, which can be easily incorporated into the observations by undergraduate students.

The presence of local dips in Franck-Hertz curves offers an alternative way of evaluating the mean free path of electrons. Figure 10 shows that the second local dip in the third minimum of the Franck-Hertz curves becomes dominant, which means that the mean free path is large enough for electrons to gain the additional energy of $\Delta E = 1.7 \text{ eV}$. Therefore, the value of λ can be estimated as:

$$\lambda = \frac{\Delta E}{eU_2} L. \quad (8)$$

With $\Delta E = 1.7 \text{ eV}$, $U_2 = 60 \text{ V}$ (third minimum), and $L = 6 \text{ mm}$, the mean free path of the electrons for inelastic collisions in the neon tube is $\lambda = 0.17 \text{ mm}$.

The mean free path of the electrons in the neon tube can be estimated in the same way as for the mercury tube by using Eq. (5), assuming a homogeneous distribution of the lower excited levels in atoms, and neglecting the local dip substructure in Franck-Hertz curves. The spacing between the main minima in the Franck-Hertz curves for the neon atoms is shown in Fig. 12 as a function of n . Similar to the mercury tube, the spacings increase linearly with n . According to Eq. (4) the energy of the lowest excited level of neon atoms can be determined from the linear fit of $\Delta E(n)$ as $E_{a1} = \Delta E(0.5) = 16.5 \pm 0.2 \text{ eV}$. This value compares well with the data in Fig. 11. The slope of the linear fit of $\Delta E(n)$ in Fig. 12 is $d\Delta E/dn = 1 \text{ V}$. From this slope and Eq. (5), the mean

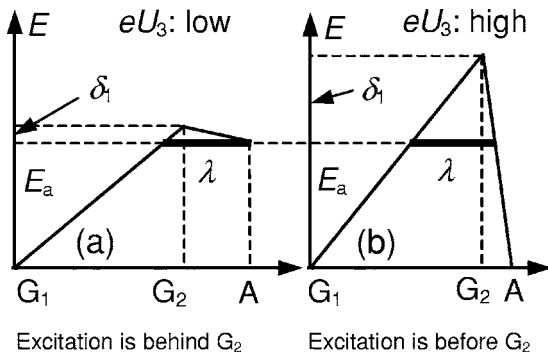

Fig. 13. Electron energy E between the grid G_1 and anode A at (a) low and (b) high values of the retarding potential U_3 . E_a is the lowest excitation energy of the atoms and δ_1 is the additional energy gained by the electron along the mean free path λ .

free path of the electrons in the neon tube is $\lambda=0.18$ mm. This value is in good agreement with our estimate from Eq. (8).

Figure 10 shows that an increase in the retarding potential U_3 shifts the Franck-Hertz curves to the right, which means that a higher accelerating voltage U_2 is required to reach the same minima in the Franck-Hertz curve. The reason is that the excitation of neon atoms occurs not only in front of the grid G_2 , but also behind this grid, especially if the electric field between G_2 and the anode is less than the field between the two grids, as is shown in Fig. 13(a). At high values of U_3 [see Fig. 13(b)] the excitation occurs mostly before the grid G_2 , which corresponds to the approximation of our model. For many minima, the influence of the retarding potential U_3 is important for the last excitation only and Eq. (3) becomes accurate for both cases.

VI. SUMMARY

We have discussed a new observation for the Franck-Hertz experiment for mercury and neon tubes; that is, the spacings between the minima in a Franck-Hertz curve increase linearly with the number of minimum. To explain this effect we have taken into account the additional acceleration of the electrons over their mean free path after the excitation energy is reached. The model is consistent with experimental data and allows an accurate estimate of the lowest excitation energy of the atoms and the mean free path of the electrons.

We also presented the first accurate determination of the energy of the first excited levels in mercury and neon using a standard Franck-Hertz experiment. Franck-Hertz curves obtained with a mercury tube at different temperatures show a reciprocal dependence of the mean free path of the electrons on the atomic density and permit us to determine the cross section of inelastic collisions of electrons with atoms. Our approach upgrades a typical Franck-Hertz experiment from a demonstration to an experiment well suited for advanced undergraduate laboratories.

ACKNOWLEDGMENTS

The authors appreciate the support of Phywe Systeme GmbH & Co. KG, which supplied a new version of the Franck-Hertz apparatus.

^{a)}Electronic mail: baev@physnet.uni-hamburg.de

¹J. Franck and G. Hertz, "Über Zusammenstöße zwischen Elektronen und Molekülen des Quecksilberdampfes und die Ionisierungsspannung desselben," *Verh. Dtsch. Phys. Ges.* **16**, 457–467 (1914).

²*Nobel Lectures, Physics, 1922–1941* (Elsevier, Amsterdam, 1965), pp. 98–129.

³J. S. Huebner, "Comment on the Franck-Hertz experiment," *Am. J. Phys.* **44**, 302–303 (1976).

⁴W. Buhr and W. Klein, "Electron impact excitation and UV emission in the Franck-Hertz experiment," *Am. J. Phys.* **51**, 810–814 (1983).

⁵D. R. A. McMahon, "Elastic electron-atom collision effects in the Franck-Hertz experiment," *Am. J. Phys.* **51**, 1086–1091 (1983).

⁶F. H. Liu, "Franck-Hertz experiment with higher excitation level measurements," *Am. J. Phys.* **55**, 366–369 (1987).

⁷G. F. Hanne, "What really happens in the Franck-Hertz experiment with mercury," *Am. J. Phys.* **56**, 696–700 (1988).

⁸W. Fedak, D. Bord, C. Smith, D. Gawrych, and K. Linderman, "Automation of the Franck-Hertz experiment and the Tel-X-Ometer x-ray machine using LABVIEW," *Am. J. Phys.* **71**, 501–506 (2003).

⁹M. Brai, R. Butt, A. Grünemaier, K. Hermbecker, and O. Schenker, "Laboratory experiments: Physics," PHYWE series, LEP 5.1.03. See http://www.fizika.org/skripte/of-prakt/5_1_03.pdf.

¹⁰H. Haken and H. C. Wolf, *The Physics of Atoms and Quanta*, 6th ed. (Springer, Heidelberg, 2000), p. 305.

¹¹F. Sigeneger, R. Winkler, and R. E. Robson, "What really happens with the electron gas in the famous Franck-Hertz experiment?," *Contrib. Plasma Phys.* **43**, 178–197 (2003).

¹²P. Nicoletopoulos, "Critical potentials of mercury with a Franck-Hertz tube," *Eur. J. Phys.* **23**, 533–548 (2002).

¹³A. N. Nesmeyanov, *Vapor Pressure of the Chemical Elements*, edited by R. Gary (Elsevier, Amsterdam, 1963).

¹⁴C. E. Moore, *Atomic Energy Levels* (National Bureau of Standards, Washington, D.C., 1949), Vol. I, p. 76.